



Standard Test Method for Leeb Hardness Testing of Steel Products¹

This standard is issued under the fixed designation A 956; the number immediately following the designation indicates the year of original adoption or, in the case of revision, the year of last revision. A number in parentheses indicates the year of last approval. A superscript epsilon (ε) indicates an editorial change since the last revision or reapproval.

1. Scope*

1.1 This test method covers the determination of the Leeb hardness of steel, cast steel, and cast iron (Part A), including the methods for the verification of Leeb hardness testing instruments (Part B), and the calibration of standardized test blocks (Part C).

NOTE 1—The original title of this standard was “Standard Test Method for Equotip Hardness Testing of Steel Products.”¹

1.2 The values stated in inch-pound units are to be regarded as standard. The values given in parentheses are mathematical conversions to SI units that are provided for information only and are not considered standard.

1.3 *This standard does not purport to address all of the safety concerns, if any, associated with its use. It is the responsibility of the user of this standard to establish appropriate safety and health practices and determine the applicability of regulatory limitations prior to use.*

2. Referenced Documents

2.1 *ASTM Standards:*²

E 691 Practice for Conducting an Interlaboratory Study to Determine the Precision of a Test Method

3. Terminology

3.1 *Definitions:*

3.1.1 *calibration*—determination of the values of the significant operating parameters of the instrument by comparison with values indicated by a reference instrument or by a set of reference standards.

3.1.2 *Leeb hardness number*—a number equal to the ratio of the rebound velocity to the impact velocity of a 3-mm or 5-mm (based on the type of impact device) diameter tungsten carbide ball or diamond tipped impact body, multiplied by 1000.

¹ This test method is under the jurisdiction of ASTM Committee A01 on Steel, Stainless Steel and Related Alloys and is the direct responsibility of Subcommittee A01.06 on Steel Forgings and Billets.

Current edition approved Sept. 1, 2006. Published September 2006. Originally approved in 1996. Last previous edition approved in 2002 as A 956 – 02.

Leeb and Equotip are registered trademarks used with permission of Proceq SA.

² For referenced ASTM standards, visit the ASTM website, www.astm.org, or contact ASTM Customer Service at service@astm.org. For *Annual Book of ASTM Standards* volume information, refer to the standard's Document Summary page on the ASTM website.

$$L = \frac{\text{Rebound Velocity}}{\text{Impact Velocity}} \times 1000$$

The Leeb hardness number is followed by the symbol *HL* with one or more suffix characters representing the type of impact device.

3.1.3 *Leeb hardness test*—a dynamic hardness test method using a calibrated instrument that impacts a spherically shaped carbide ball or diamond tipped body with a fixed velocity (generated by a spring force) onto a surface of the material under test. The ratio of the rebound velocity to the impact velocity of the impact body is a measure of the hardness of the material under test.

3.1.4 *surface finish*—all references to surface finish in this test method are defined as surface roughness (that is, *Ra* = average roughness value, *AA* = arithmetic average).

3.1.5 *verification*—checking or testing the instrument to ensure conformance with this test method.

4. Significance and Use

4.1 Hardness of a material is a poorly defined term that may have many meanings depending on the type of test performed and the expectations of the person involved. The Leeb hardness test is of the dynamic or rebound type, which primarily depends both on the plastic and on the elastic properties of the material being tested. The results obtained are indicative of the strength and dependent on the heat treatment of the material tested.

4.2 The Leeb hardness test is a superficial determination only measuring the condition of the surface contacted. The results generated at that location do not represent the part at any other surface location and yield no information about the material at subsurface locations.

A. GENERAL DESCRIPTION OF INSTRUMENTS AND TEST PROCEDURE FOR LEEB HARDNESS TEST

5. Apparatus

5.1 The instrument used for Leeb hardness testing consists of (*I*) an impact device that is equipped with a tungsten carbide ball or synthetic diamond tipped impact body, an induction coil

*A Summary of Changes section appears at the end of this standard.

velocity measuring assembly, and a support ring, and (2) an electronic digital display hardness indicating device.

5.2 Impact Devices—There are six types of impact devices used in Leeb hardness testing. These are the *D*, *DC*, *D+15*, *G*, *C*, and the *E* impact units. Brief descriptions of the types of devices and their common applications are given in **Appendix X1**.

5.3 Summary of Test Method—During a hardness test, an impact body with a spherically shaped tungsten carbide or diamond tip impacts under spring force, the test surface from which it rebounds. The impact and rebound velocities are measured when the impact body is approximately 1 mm from the test surface. This is accomplished by means of a permanent magnet mounted in the impact body which, during the test, moves through a coil in the impact device and induces an electric voltage on both the impact and rebound movements. These induced voltages are proportional to the respective impact and rebound velocities. The quotient of these measured voltage values derived from the impact and rebound velocities, multiplied by the factor 1000 produces a number which constitutes the Leeb hardness value.

5.4 See **7.1.1** when using replacement machine components.

6. Test Piece

6.1 Form—The Leeb hardness test is acceptable for steel, cast steel, and cast iron with varying shapes and sizes.

6.2 Thickness and Weight—The thickness and weight of the test piece shall be considered when selecting the impact device to be employed. The following guidelines are offered as minimum weights and sizes of test pieces for selecting the proper test equipment. Test pieces of weights less than the minimum or pieces of any weight with sections less than the minimum thickness require rigid support and coupling to a thick, heavier non-yielding surface to resist the impact of the device. Failure to provide adequate support and coupling will produce test results lower than the true hardness value.

Impact Device	Weight (min) or	Thickness (min)
<i>D</i> , <i>DC</i> , <i>D+15</i> , <i>E</i>	15 lb (5 kg)	1/8 in. (3 mm)
<i>G</i>	40 lb (15 kg)	3/8 in. (10 mm)
<i>C</i>	4 lb (1.5 kg)	1/32 in. (1 mm)

6.3 Curvature—Test pieces with curved surfaces may be tested on either the convex or concave surfaces providing that this radius of curvature of the specimens is matched to the size of the support ring and is not less than 2 in. (50 mm) for the *G* impact device or 1 3/16 in. (30 mm) for other impact devices.

6.4 Surface Finish/Preparation—The test surface shall be carefully prepared to avoid any alterations in hardness caused by heating during grinding or by work hardening during machining. Any paint, scale, pits, or other surface coatings shall be completely removed. The surfaces to be tested shall be smooth. Failure to provide adequate surface finish will produce questionable test results. Coarse finishes will tend to lower the measured value. It is recommended that the test surface be machined or ground and polished to the following finishes. (The grinding wheel grit size shown for each finish is offered for guidance in achieving the finish noted.)

Impact Device	Surface Finish—Ra (max)	Grit Size (Approx.)

<i>D</i> , <i>DC</i> , <i>D+15</i> , <i>E</i>	63 μin. (2 μm)	200
<i>G</i>	250 μin. (7 μm)	65
<i>C</i>	16 μin. (0.4 μm)	500

6.5 Magnetic Fields—Performance of the Leeb hardness test on parts with a residual magnetic field may affect the results. It is recommended that any residual magnetic field be less than 4 G.

6.6 Vibration—Vibration of the test specimen may affect the results of the Leeb hardness test. It is recommended that this test be performed with the test piece at rest.

6.7 Temperature—The temperature of the test piece may affect the results of the test. In addition, this effect may be different for different materials. Testing to this procedure shall be performed with the temperature of the test piece between 40°F (4°C) and 100°F (38°C). At temperatures outside this range, the user shall develop a temperature correction for the specific material being tested.

7. Verification of Apparatus

7.1 Verification Method—Prior to each shift, work period, or use, and following a period of extended continuous use (1000 impacts), the instrument shall be verified as specified in Part B. Any instrument not meeting the requirements of Part B shall not be employed for the acceptance testing of product.

7.1.1 Cautionary note: When replacement parts are used in a Leeb hardness tester it is important that they be fully compatible with the original equipment, otherwise incorrect hardness readings may be obtained. Calibration using a single standard test block may indicate acceptable results, but additional calibration tests using blocks of differing hardness may yield unacceptable results. If replacement, non-original equipment parts are used, multiple block calibration verification is strongly advised. Specifically, one calibration block of a hardness equal to or lower than the minimum expected hardness of the material being tested, one calibration block of a hardness equal to or greater than the maximum expected hardness of the material being tested, and one calibration block near the middle of the range should be used.

8. Procedure

8.1 Test Method—To perform a hardness test, the impact device is connected to the indicator device and the instrument is turned on. The impact device, while not in contact with the test piece, is held firmly with one hand and the charging tube is depressed with the other hand until contact is felt. The charging tube is allowed to slowly return to the starting position. The impact body is now in its loaded or locked position. After placing the impact device on the test surface, trigger the impact body by exerting a light pressure on the release button. The Leeb hardness value is read on the indicator device.

8.2 Alignment—To prevent errors resulting from misalignment, the base support ring of the impact device shall be held snugly and perpendicular to the surface of the test piece.

8.3 Impact Direction—The impact device is calibrated for the down vertical impact direction (perpendicular to a horizontal surface). For other impact directions such as 45° from the horizontal plane or from underneath, the measured hardness

values will require adjustment (see 9.2). Some newer models automatically compensate for test direction.

8.4 *Spacing Indentations*—The distance between any two impact points shall not be less than two diameters edge-to-edge. The distance between the impact point and a specimen edge shall not be less than three diameters edge-to-edge. No point shall be impacted more than once.

8.5 *Reading the Leeb Instrument*—Hardness values in Leeb units are read directly on the electronic display of the indicator device. The indicated value is automatically replaced with the next test impact result.

8.6 *Number of Impacts*—Five impacts in an area of approximately 1 in.² (645 mm²) shall constitute a test. If the material being tested is considered to be nonhomogeneous (for example, cast iron) ten impacts in an area shall be made to constitute a test.

9. Calculation of Hardness Result

9.1 The hardness test result shall be the arithmetic average of the five individual impact readings in the measuring area.

9.2 *Correction for Test Direction*—When using an Leeb instrument without automatic compensation for test direction, the correction value for direction of test impact is to be subtracted from the average value determined for the measuring area. This correction value can be determined in accordance with Tables 1-6.

10. Conversion to Other Hardness Scales or Tensile Strength Values

10.1 There is no direct correlation between the Leeb hardness test principle and other hardness methods or a tensile strength test. All such conversions are, at best, approximations and therefore conversions should be avoided except for special

TABLE 1 Correction Values for Other Impact Directions: Device D





L _D				
300				
350	-6	-12	-20	-29
400	-6	-12	-19	-27
450	-5	-11	-18	-25
500	-5	-10	-17	-24
550	-5	-10	-16	-22
600	-4	-9	-15	-20
650	-4	-8	-14	-19
700	-4	-8	-13	-18
750	-3	-7	-12	-17
800	-3	-6	-11	-16
850	-3	-6	-10	-15
900	-2	-5	-9	-14

TABLE 2 Correction Values for Other Impact Directions: Device D + 15









L _{D + 15}				
300				
350	-7	-14	-26	-38
400	-7	-13	-25	-36
450	-6	-12	-23	-34
500	-6	-12	-22	-32
550	-6	-11	-21	-30
600	-6	-11	-20	-28
650	-5	-10	-19	-27
700	-5	-10	-18	-25
750	-5	-9	-17	-24
800	-4	-9	-16	-22
850	-4	-8	-15	-21
900	-4	-8	-14	-20

TABLE 3 Correction Values for Other Impact Directions: Device E





L _E				
300				
350	-5	-9	-18	-26
400	-4	-9	-17	-24
450	-4	-9	-16	-22
500	-4	-8	-15	-21
550	-4	-8	-14	-20
600	-4	-8	-13	-18
650	-3	-7	-12	-17
700	-3	-7	-12	-16
750	-3	-6	-11	-15
800	-3	-6	-10	-14
850	-3	-5	-9	-13
900	-2	-5	-8	-12

cases where a reliable basis for the approximate conversion and the accuracy of the conversion has been obtained by comparison testing. No conversions shall be employed without specific agreement between the party specifying this test method and the party performing the hardness test.

11. Report





11.1 Report the following information:

TABLE 4 Correction Values for Other Impact Directions: Device C

L_C				
350			A	A
400	-7	-15		
450	-7	-14		
500	-7	-13		
550	-6	-13		
600	-6	-12		
650	-6	-11		
700	-5	-10		
750	-5	-10		
800	-4	-9		
850	-4	-8		
900	-4	-7		
950	-3	-6		

^A Not permitted.

TABLE 5 Correction Values for Other Impact Directions: Device G (Steel)

L_G				
300			-12	-18
350	-11	-17
400	-11	-16
450	-2	-5	-10	-15
500	-9	-14
550	-9	-13
600	-8	-12
650	-8	-11
700	-7	-10
750		

11.1.1 The average Leeb hardness number for each test area with the impact device indicated (for example, xxx *HLD* or xxx *HLD*+15).





11.1.2 When hardness values converted from the Leeb number are reported, the instrument used shall be reported in parentheses, for example, *HB (HLG)*.

12. Precision and Bias

12.1 *Precision:*

12.1.1 *Interlaboratory Test Program*—An interlaboratory test program was conducted in accordance with to develop

TABLE 6 Correction Values for Other Impact Directions: Device G (Grey Cast Iron)

L_G				
350	-11	-17
400	-11	-16
450	-2	-5	-10	-15
500	-9	-14
550	-9	-13
600		

information regarding the precision of the Leeb hardness measurements. Eight laboratories tested five certified test blocks. Each laboratory measured the hardness of each block 25 times.

12.1.2 *Test Result*—The precision information given below is the average of the five certified test blocks, each of a different hardness.

12.1.3 *Repeatability and Reproducibility:*

95 % Repeatability Limit (within laboratory) = 4.4 %
 95 % Reproducibility Limit (between laboratories) = 8.8 %

12.1.3.1 The terms in 12.1.3 (repeatability limit and reproducibility limit) are used as specified in Practice E 691. The respective standard deviations among test results, related to the above numbers by the factor 2.8, are:

Repeatability Standard Deviation = 1.6 %
 Reproducibility Standard Deviation = 3.2 %

12.2 *Bias*—Since hardness is not an intrinsic property of a material, there is no basis on which to determine or assign an accepted reference value. Consequently, there is no basis for defining the bias of this test method.

B. VERIFICATION OF LEEB HARDNESS INSTRUMENTS

13. Scope

13.1 Part B covers the procedure for verification of Leeb hardness instruments by a standardized block method.

14. General Requirements

14.1 Before a Leeb hardness instrument is verified, the instrument shall be examined to ensure that:

14.1.1 The batteries in the indicating device are not discharged, and faulty batteries are replaced as required.

14.1.2 The impact device is clean, and the spherical tip of the impact body is free from all foreign matter (for example, dust, dirt, grease, scale, etc.).

14.1.3 The tip of the impact body is free from cracks or deformed areas.

14.1.4 The test block is placed on a clean, level, firmly supported base.

15. Verification by Standardized Test Blocks

15.1 Check the Leeb hardness instrument by making two impacts on a standardized test block.

15.2 The Leeb hardness instrument shall be considered verified if the individual readings fall within ± 6 HL units of the reference value. Any instrument not verified shall not be used for testing without repair and re-verification.

C. CALIBRATION OF STANDARDIZED HARDNESS TEST BLOCKS FOR LEEB HARDNESS INSTRUMENTS

16. Scope

16.1 Part C covers the calibration of standardized hardness test blocks used for the verification of Leeb hardness instruments.

17. Manufacture

17.1 Each test block shall be made of steel with dimensions not less than $3\frac{1}{2}$ in. (90 mm) in diameter by $2\frac{1}{8}$ in. (54 mm) thick for impact devices *D*, *DC*, *D+15*, *C*, and *E* and $4\frac{3}{4}$ in. (120 mm) in diameter by $2\frac{3}{4}$ in. (70 mm) thick for impact device *G*. The two opposite end plane surfaces shall be parallel.

17.2 Each block shall be specifically prepared and heat treated to give a specific hardness and the necessary homogeneity and stability of structure.

17.3 Each steel block shall be demagnetized by the manufacturer and maintained demagnetized by the user.

17.4 A non-test surface of the test block shall have a fine ground finish of 250 μin . (7 μm) maximum.

17.5 The test surface shall be polished or fine ground and free of scratches and other discontinuities which would influence the rebound characteristics of the test block.

17.6 The surface finish of the test surface shall not exceed 16 μin . (0.4 μm) maximum.

17.7 To ensure that no material is subsequently removed from the test surface of the standardized test block, an official

mark or the thickness to an accuracy of ± 0.001 in. (± 0.025 mm) at the time of calibration shall be marked on the test surface.

18. Standardizing Procedure

18.1 The standardizing hardness test blocks shall be calibrated with an Leeb instrument for which the operational characteristics have been certified by the manufacturer and which has been verified in accordance with the requirements of Part B.

18.2 Make ten randomly distributed hardness impacts on the test surface of the test block.

18.3 Take the arithmetic mean of all of the readings as the mean hardness of the test block.

19. Uniformity of Hardness

19.1 Unless the difference between the largest and the smallest of the ten readings is less than 13 Leeb units, the block cannot be regarded as sufficiently uniform for standardization purposes.

20. Marking

20.1 Each block shall be marked with:

20.1.1 Arithmetic mean of the hardness values found in the standardization test suffixed by the scale designation letter (for example, *HLD*).

20.1.2 The name or mark of the supplier.

20.1.3 The thickness of the test block.

21. Keywords

21.1 dynamic hardness test; Equotip; Equotip hardness test; Leeb; rebound hardness test

APPENDIXES

(Nonmandatory Information)

X1. STANDARD SINGLE COIL REBOUND HARDNESS TESTERS ACCORDING TO THE LEEB PRINCIPLE

X1.1 General Description

X1.1.1 There are seven established types of impact devices for rebound hardness testers according to the Leeb principle: *D*, *DC*, *E*, *D+15*, *DL*, *C*, and *G*. The impact devices *D* and *E* have become industry standards for general purpose applications since the first introduction of the *D*-device in 1975. The other types have been added with the time for applications with special requirements. For more details, see X1.4.

X1.1.2 It is well known that the *L*-readings for a given specimen differ significantly, depending on the impact device type used. The main reasons for this are:

- X1.1.2.1 Different impact energies;
- X1.1.2.2 Different sizes and materials of the indenter; and
- X1.1.2.3 Different stiffnesses of the impact bodies.

X1.1.3 One important advantage of the Leeb testing method is, that it can be used for any direction. The results are, however, not completely independent on the impact angle. Each of the standard probes has its own characteristic direction dependency, which is determined by:

X1.1.3.1 The combination of the impact velocity and the free flight length of the impact body; and

X1.1.3.2 The shape of the induction voltage signal, which is determined by the velocity versus time curve on the one hand and by the characteristics of the sensor coil and the permanent magnet on the other hand.

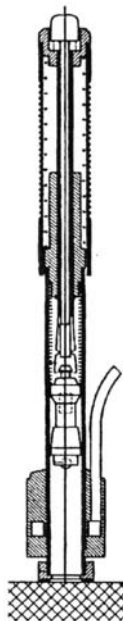

FIG. X1.1 Impact Device D

X1.1.4 For the standard single coil rebound hardness testing devices, a typical induction voltage curve is sketched in Fig. X1.2 where the shape of this curve is unique for all impact devices of this type. The impact and rebound velocities are assumed to be proportional to the extremal values *A* and *B* of the signal curve, which is a good approximation, if the device is constructed so, that the extremals are near the signal step caused by the impact. If they are too near, however, the reproducibility of the measurement suffers, because the signal is often disturbed short after the impact. The width of the signal curve has some influence on the result, because it determines, how good the proportionality between minimum value *B* and rebound velocity is.

X1.1.5 Another parameter of paramount importance determining the actual *L* value for a material of a given hardness is the impact energy, which follows from the impact velocity, the mass of the impact body, and its stiffness (which determines how much energy the impact body absorbs). In order to reproduce the standard direction dependency, it is necessary to specify velocity and mass separately and to have a specific free flight length. This means that the impact energy in general is the most important parameter for significance of *L*-values for all rebound hardness testers working in units of the seven different standard impact devices listed in 5.1 and given in Table X1.1. Furthermore, the *L* value depends on the geometry of the indenter and its material properties, predominantly hardness and elasticity.

X1.1.6 Finally, the effect of deceleration by eddy currents may affect the result. So the tube material must be specified, too, as well as special precautions have to be taken to reduce eddy currents.

X1.2 Specifications of Standard Single Coil Hardness Testers

X1.2.1 Table X1.1 compiles the relevant specification for impact devices *D/DC*, *E*, *D+15*, *DL*, *C*, and *G*. Coil and permanent magnet are not explicitly specified. They have to be chosen in such a way, that the specified parameters of the induction voltage signal are fulfilled. For the definition of some of the parameters refer to Fig. X1.2.

X1.3 Impact Direction Compensation

X1.3.1 Rebound hardness testing devices designed according to the above specifications will not only give correct readings for vertical downward impacts, but will also have a characteristic dependency on the impact angle as shown in Tables X1.2-X1.8.

X1.3.2 Tables X1.2-X1.8 can be used for instruments determining only the velocity ratio in order to correct the readings

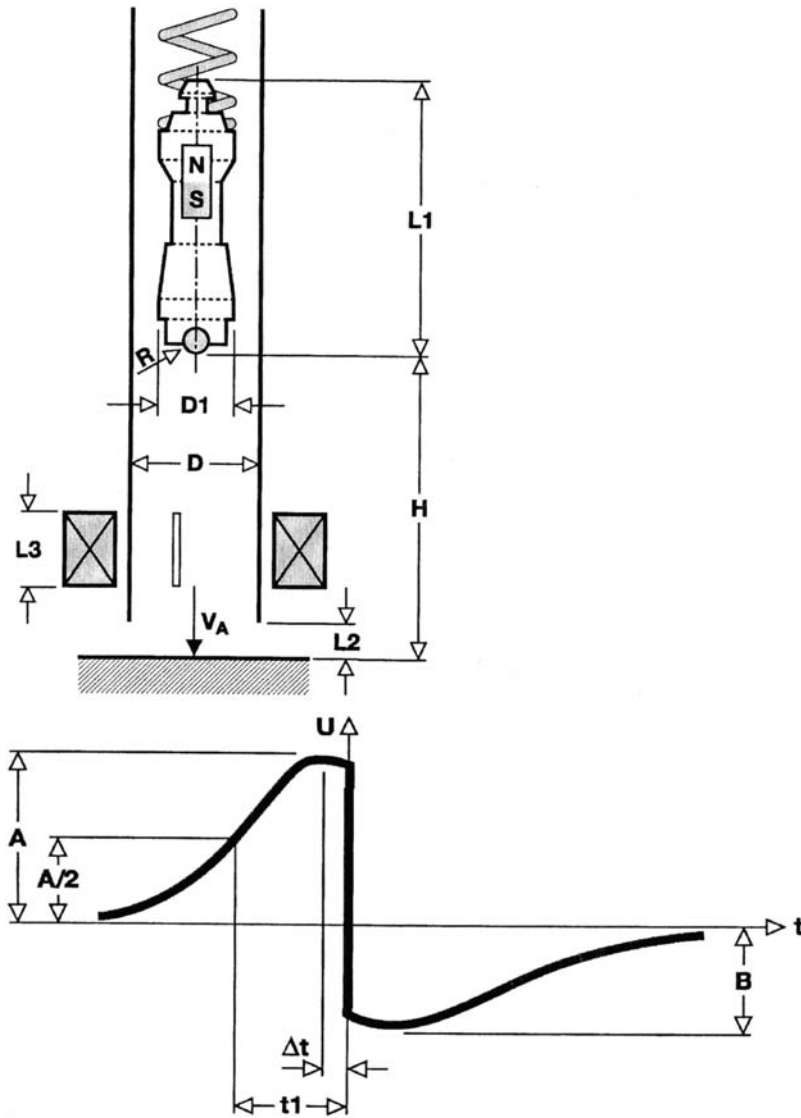

FIG. X1.2 Principle of Standard Single Coil Leeb Hardness Testers

TABLE X1.1 Specifications of Standard Single Coil Leeb Hardness Testing Devices

Property	Symbol	Unit	D/DC	E	D+15	DL	C	G
Impact velocity ^A	v_A	m/s	$2.05 \pm 1\%$	$2.05 \pm 1\%$	$2.05 \pm 1\%$	$2.05 \pm 1\%$	$1.39 \pm 2\%$	$2.98 \pm 1\%$
Impact body, mass material: St 18/8, nonmagnetic	M	G	$5.45 \pm 0,05$	$5.45 \pm 0,05$	$7.80 \pm 0,05$	$7.23 \pm 0,05$	$3.00 \pm 0,05$	$20.00 \pm 0,05$
Free flight length Tube material: aluminium, nonmagnetic	H	mm	8 ± 1	8 ± 1	8 ± 1	8 ± 1	8 ± 1	15 ± 1
Eddy current slit			yes	no	yes	yes	yes	no
Indenter, radius material	R	mm	1.5 TC ^B	1.5 PKD ^C	1.5 TC	1.5 TC	1.5 TC	2.5 TC
hardness	h	HV	1600 (typ)	5000 (typ)	1600 (typ)	1600 (typ)	1600 (typ)	1600 (typ)
Induction signal, peak position half width	t_1 Δt	ms	$0.55 \pm 0,15$ $2.5 \pm 30\%$	$0.55 \pm 0,15$ $2.5 \pm 30\%$	$0.55 \pm 0,15$ $2.5 \pm 30\%$	$0.55 \pm 0,15$ $2.5 \pm 30\%$	$0.62 \pm 0,20$ $4.0 \pm 30\%$	$0.55 \pm 0,15$ $2.0 \pm 30\%$

^A Impact direction: vertical down.

^B TC = tungsten carbide.

^C PCD = polycrystalline diamond.

manually for other directions than vertically down. With microprocessor controlled instruments, the user may set the

impact direction and the instrument can determine and display the appropriately corrected values automatically. Instruments

TABLE X1.2 Impact Direction Corrections, Probe D/DC





L_D				
300	-6	-12	-20	-29
350	-6	-12	-19	-27
400	-5	-11	-18	-25
450	-5	-10	-17	-24
500	-5	-10	-16	-22
550	-4	-9	-15	-20
600	-4	-8	-14	-19
650	-4	-8	-13	-18
700	-3	-7	-12	-17
750	-3	-6	-11	-16
800	-3	-6	-10	-15
850	-2	-5	-9	-14
900				

TABLE X1.4 Impact Direction Corrections, Probe D+15





L_D				
300	-7	-14	-26	-38
350	-7	-13	-25	-36
400	-6	-12	-23	-34
450	-6	-12	-22	-32
500	-6	-11	-21	-30
550	-6	-11	-20	-28
600	-5	-10	-19	-27
650	-5	-10	-18	-25
700	-5	-9	-17	-24
750	-4	-9	-16	-25
800	-4	-8	-15	-21
850	-4	-8	-14	-20
900				

TABLE X1.3 Impact Direction Corrections, Probe E







L_E				
300	-5	-9	-18	-26
350	-4	-9	-17	-24
400	-4	-9	-16	-22
450	-4	-8	-15	-21
500	-4	-8	-14	-20
550	-4	-8	-13	-18
600	-3	-7	-12	-17
650	-3	-7	-12	-16
700	-3	-6	-11	-15
750	-3	-6	-10	-14
800	-3	-5	-9	-13
850	-2	-5	-8	-12
900				

TABLE X1.5 Impact Direction Corrections, Probe C

L_E		
300	-7	-15
350	-7	-14
400	-7	-13
450	-6	-13
500	-6	-12
550	-6	-11
600	-5	-10
650	-5	-10
700	-4	-9
750	-4	-8
800	-4	-7
850	-3	-6
900		

containing some means for determining the impact angle can make a fully automatic direction correction, eliminating the possibility of incorrect instrument settings by the user.

X1.4 Guidelines for Selection and Use of the Different Impact Devices

Impact Device *D*

max. hardness up to 68 HRC	dimensions ø 20 × 147 mm
-------------------------------	-----------------------------

X1.4.1 The universal unit for the majority of hardness measurements with a wide measuring range. Applications on steel and cast steel, cold work tool steel, stainless steel, cast iron (lamellar and nodular graphite), cast aluminium alloys, brass, bronze, wrought copper alloys low alloyed. Impact bodies tend to wear out at the high end of hardness range.

Impact Device *DC*

max. hardness up to 68 HRC	dimensions ø 20 × 86 mm
-------------------------------	----------------------------

TABLE X1.6 Impact Direction Corrections, Probe G, Steel









L_D				
300				
350	-2	-5	-12	-18
400	-2	-5	-11	-17
450	-2	-5	-11	-16
500	-2	-5	-10	-15
550	-2	-5	-9	-14
600	-2	-5	-9	-13
650	-2	-5	-8	-12
700	-2	-5	-8	-11
750	-2	-5	-7	-10

TABLE X1.7 Impact Direction Corrections, Probe G, Cast Materials

L_E				
350				
400	-2	-5	-11	-17
450	-2	-5	-11	-16
500	-2	-5	-10	-15
550	-2	-5	-9	-14
600	-2	-5	-9	-13

X1.4.2 Short impact device which has the same properties and applications like the impact device *D*. Special applications in very confined spaces like holes, cylinders or measurements inside of assembled machines and constructions.





Impact Device *D*+15
 max. hardness up to 68 HRC dimensions $\varnothing 20 \times 162$ mm

X1.4.3 Same range of applications like *D/DC* but particularly is slim front section which allows hardness measurements in holes and grooves and on recessed surfaces (elongated impact body and coil position 15 mm elevated).

Impact Device *G*
 max. hardness up to 646 HB dimensions $\varnothing 30 \times 254$ mm

X1.4.4 Increased impact energy (approximately 9 times of that for the standard impact device *D*). Application in the

TABLE X1.8 Impact Direction Corrections, Probe DL

L_D				
550				
600	-3	-6	-11	-16
650	-3	-5	-10	-14
700	-2	-5	-9	-13
750	-2	-4	-7	-12
800	-2	-3	-6	-10
850	-2	-3	-5	-9
900	-2	-2	-4	-7
950	-2	-2	-3	-6

Brinell-range on heavy coarse grained castings and forgings, on steel and cast steel, cast iron (lamellar and nodular graphite) and cast aluminium. Requires less surface finish than impact device *D* for accurate readings.

Impact Device *E*
 max. hardness up to 72 HRC dimensions $\varnothing 20 \times 155$ mm

X1.4.5 Synthetic diamond test tip (approximately 5000 HV). Same materials to be tested like standard *D* unit but at extended hardness range. Applications for measurement in the high end range, for example, on steel and cast steel, stainless steel, cold work tool steel with carbide inclusions and on rolls in the hardness range up to 1200 HV. Impact bodies show no fading even at high hardness levels compared to *D* device.

Impact Device *C*
 max. hardness up to 70 HRC dimensions $\varnothing 20 \times 141$ mm

X1.4.6 Reduced impact energy (approximately 1/4 of that for impact device *D*) and therefore covers slightly wider hardness range than device *D*. Applications on surface hardened components, coatings. Min. layer thickness of 0.3 mm. Applications on walled or impact sensitive components (small measuring indentation) too. Measurements on steel and cast steel, cold work tool steel and cast aluminium alloys. Requires better surface finish than impact device *D*.

Impact Device *DL*
 max. hardness up to 68 HRC dimensions $\varnothing 20 \times 202$ mm

X1.4.7 Same range of applications like *D*+15 but has the speciality of more slim front section ($\varnothing 4 \times 50$ mm) for use in confined spaces and at the base of grooves, drill holes, and gears respectively.

X2. GENERAL DESCRIPTION AND TEST PROCEDURE FOR LEEB HARDNESS TEST ACCORDING TO THE MULTIPLE-COIL INSTRUMENT

X2.1 Scope

X2.1.1 The patented rebound method by Krautkramer is a further development of the original Leeb method (see Appendix X1). The measurement readings determined by the latter method are erroneous due to gravitational acceleration and are not independent of direction. The results must therefore be correspondingly corrected. This disadvantage is not apparent in instruments which operate according to the Krautkramer rebound method.

X2.1.2 The direction-dependence of the measurement readings result essentially from:

X2.1.2.1 A kinematic error caused by gravitational force and friction (at the measurement location t_a resp. t_a'), if not measured within the impact time t_{00} (refer to Fig. X2.1); and

X2.1.2.2 A change in the effective, influencing energy depending on the position resp. direction being applied.

X2.1.3 The first effect is avoided by evaluation of a time signal correlated with location information of the impact body. It is of advantage to arrange the impact body (magnets) and the coil so that the impact signal as well as the rebound signal uses at least two zero transitions (in this case 3) of the induced voltage as support points for the evaluation of the curve. The complete curve is digitized for evaluation and mapped into the instrument's memory.

X2.1.4 The second effect is compensated by calibration of the impacting device in the various application positions and at various degrees of hardness.

X2.2 General Description of Instruments and Test Procedure for Leeb Hardness Test According to the Krautkramer Instrument

X2.2.1 Compensation of Kinematic Error

X2.2.1.1 The signal curve according to Fig. X2.1 is produced during the impact and rebound trip of the impact body, using the sophisticated coil arrangement outlined in Fig. X2.2. The primary part of the curve (index prefixed with "0") is produced by the impact and the secondary part of the curve

(indicated with the prefix "1") by the return trip. The moments t_{01}, t_{02}, t_{03} correspond to t_{11}, t_{12}, t_{13} , that is, at these times the impact body is correspondingly at the same position $x(t_0) = x(t_1)$, also $x(t_{01}) = x(t_{11}); x(t_{02}) = x(t_{12})$ and $x(t_{03}) = x(t_{13})$.

X2.2.1.2 Using the magnetic flow through a coil with the surface A :

$$\Phi(t) = \int_A B(r,t) \cdot dA \tag{X2.1}$$

where:

$B(r,t)$ = magnetic field,

t = time, and

r = position.

X2.2.1.3 The time progression of the coil voltage can be calculated:

$$u(t) = c(x(t))v(t) \tag{X2.2}$$

where:

$c(x(t))$ = function of the position of the impact body, and

$v(t)$ = velocity of the impact body.

X2.2.1.4 The ratio of the voltage at the moment of impact must be found, that is:

$$h = \frac{v_1(0)}{v_0(0)} \tag{X2.3}$$

X2.2.1.5 Using the reproduction law $t_1(t_0)$ produces $x(t_0) = x(t_1(t_0))$ also at the same position as $c(t_0) = c(t_1(t_0))$ which in turn produces:

$$\frac{u(t_1(t_0))}{u(t_0)} = \frac{c(x(t_1(t_0)))}{c(x(t_0))} \frac{v(t_1(t_0))}{v(t_0)} = \frac{v(t_1(t_0))}{v(t_0)} = v_{10}(t_0) \tag{X2.4}$$

X2.2.1.6 The ratio of the induction voltages is therefore the same as the ratio of the velocity to the corresponding times.

X2.2.1.7 Three curve points for the reproduction law $t_1(t_0)$ can be found after determination of the zero points from the measurement signal. The complete reproduction law is obtained by interpolation between these curve points so that the corresponding amplitude value $u(t_1)$ can be allocated to each voltage value $u(t_0)$ enabling the velocity ratio (except at the zero positions themselves) to be calculated. Finally extrapolation takes place at the required impact time. The starting point is the ratio t_a' / t_a which corresponds to the uncorrected measurement reading according to Leeb (see Appendix X1).

X2.2.1.8 The method guarantees a considerable tolerance with regard to the characteristics of the impact device enabling exchange of the impact body without any difficulty and without having to recalibrate the instrument. Only the mass must be kept within narrow tolerances. As opposed to this, the position of the zero points, and to a certain amount also the minimum at t_a , vary (magnetic field geometry) without causing any incorrect readings worth mentioning about.

X2.2.2 Correction of the Impact Energy at Different Impact Directions and Production Tolerances of the Impact Devices

X2.2.2.1 The impact devices are calibrated in order to compensate the dependence of the velocity ratio on the impact energy as well as the differences in the mechanical design of

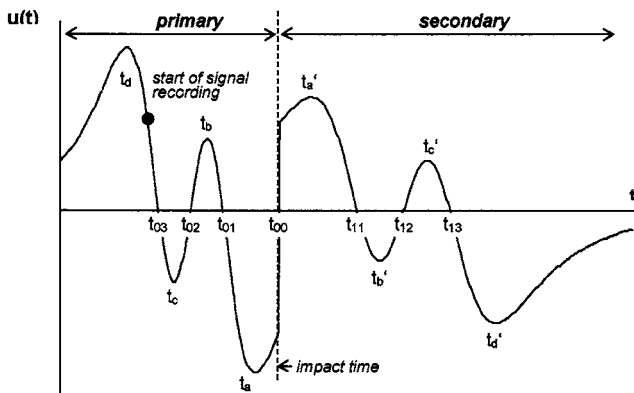

FIG. X2.1 Schematic Voltage Signal Generated By the Impact Body Travelling Through the Krautkramer Coil System

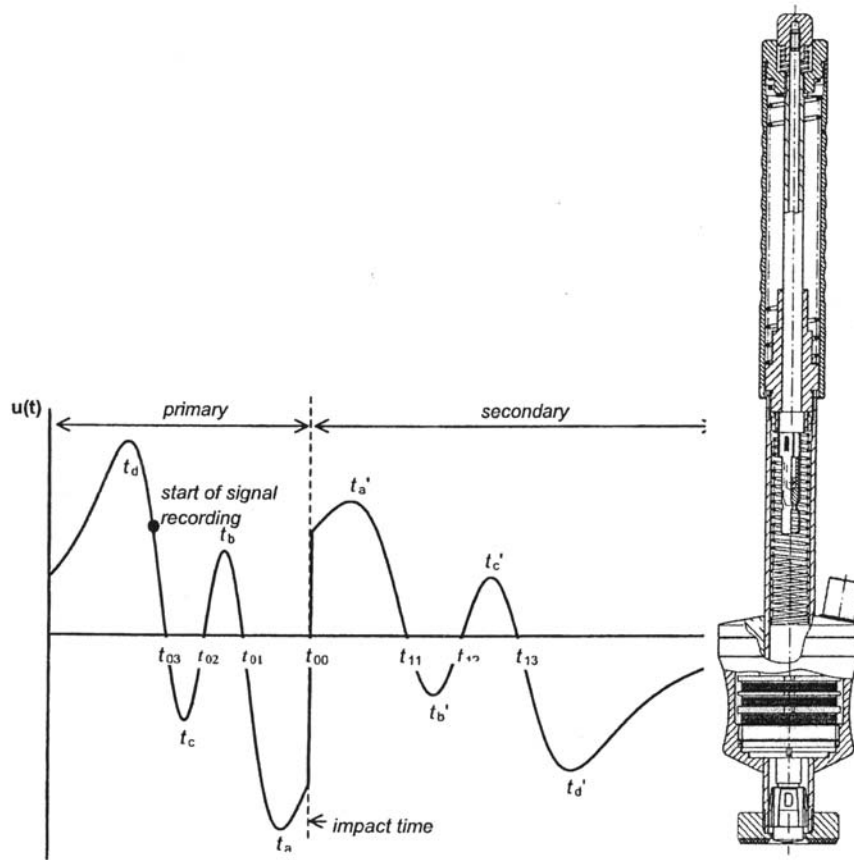

FIG. X2.2 Design of the Kraukramer Impact Device D

the impact device. To do this, the rebound values are measured, as described above, on two hardness reference blocks having different, known hardness values. Three measurements are made for each of the five impact directions, +90° (vertically downwards), +60°, 0° (horizontal), -60° and -90° (vertically upwards). In addition to the hardness, the time interval Δt between the zero transitions t_{03} and t_{01} is recorded in units having $1/64$ scanning steps (approximately 0.7 μ s). This is a measure for the velocity of the impact body: high velocities correspond to small Δt , lower velocities to large Δt . Owing to the different orientations during the measurement sequence, one obtains complete coverage of the impact energy range occurring when in operation.

X2.2.2.2 The difference Δh between the uncalibrated, measured Leeb hardness and the prespecified reference block hardness against Δt is plotted for all measurement points and both the resulting relationships are corrected by straight lines. The gradients of the correction lines are stored in the serial

EPROM in the impact device together with the reference block hardness and the position (Δt_0 , Δh_0) of the intersection points of both lines.

X2.2.2.3 If the measurement produces an uncalibrated hardness in Leeb according to see [Appendix X1](#), then the corresponding gradient of the correction lines are determined by linear interpolation of the gradient established during the calibration process.

X2.2.2.4 The dependence of the measurement reading on the changed friction is, within certain limits, also taken into consideration (in addition to the dependence on impact direction). Both effects lead to a change in impact energy. Furthermore, small differences, caused by production, in potential energy of the impact body in the tensioned state are compensated. Whereas the information about the required velocity correction is essentially contained in the line gradient, deviations of the probe's mechanical characteristics are essentially reflected in a vertical shift of the curve.

SUMMARY OF CHANGES

Committee A01 has identified the location of selected changes to this standard since the last issue (A 956 – 02) that may impact the use of this standard. (Approved Sept. 1, 2006.)

(I) Added **5.4** and **7.1.1**.

ASTM International takes no position respecting the validity of any patent rights asserted in connection with any item mentioned in this standard. Users of this standard are expressly advised that determination of the validity of any such patent rights, and the risk of infringement of such rights, are entirely their own responsibility.

This standard is subject to revision at any time by the responsible technical committee and must be reviewed every five years and if not revised, either reapproved or withdrawn. Your comments are invited either for revision of this standard or for additional standards and should be addressed to ASTM International Headquarters. Your comments will receive careful consideration at a meeting of the responsible technical committee, which you may attend. If you feel that your comments have not received a fair hearing you should make your views known to the ASTM Committee on Standards, at the address shown below.

This standard is copyrighted by ASTM International, 100 Barr Harbor Drive, PO Box C700, West Conshohocken, PA 19428-2959, United States. Individual reprints (single or multiple copies) of this standard may be obtained by contacting ASTM at the above address or at 610-832-9585 (phone), 610-832-9555 (fax), or service@astm.org (e-mail); or through the ASTM website (www.astm.org).